

Quick Installation

Solar pumping inverter

JNP370LS-V1

JNP550LS-V1

QI-JNP-550LS-V1-EN-V1.0

The copyright belong to Supplier.

This document involves the proprietary and confidential information about Solar pumping inverter of Supplier. It strictly prohibited to disclose the document by duplicating, photocopying, publishing online and in other forms without SUPPLIER's permission.

Supplier. reserves the right to change details in this publication without notice.

Contents

1 Inverter unpacking.....	1
2 Installation procedure.....	2
2.1 Prepare installation tools.....	2
2.2 Installation Direction and spacing dimension.....	2
2.3 Installation of Inverter.....	3
3 Electrical Connection.....	5
3.1 Connecting Terminals of Inverter.....	5
3.2 Cable Selection for Electrical Connection.....	6
3.3 AC Side Electrical Connection.....	7
3.3.1 Single phase pump description.....	7
3.3.2 Capacitor removal example.....	9
3.4 DC side connection.....	11
3.5 Inverter grounding.....	13
3.6 Water Level Sensor Connection.....	14
3.6.1 Water level sensor interface define.....	14
3.6.2 Water level sensor connection.....	15
4 Disassembling.....	17
4.1 The Disassembling of PV Connector.....	17
5 Commissioning.....	17
5.1 Verify before Commissioning.....	18
5.2 Inverter first commission.....	20
6 Appendix: Troubleshooting.....	22

1 Inverter unpacking

Check according to Packing List whether all the parts are correct and in good condition or not. Accessories are shown as below:



Figure 1-1 inverter and common accessories

Table 1-1 description of inverter and common accessories





No	Description	No	Description
1	Solar pumping inverter	7	Packing list
2	Blue ring tool	8	Water level sensor A
3	Expansion bolt	9	Quick installation guideline
4	PV connector	10	Water level sensor B
5	Water pump connector	11	Certification of inspection
6	Sensor and communication connector (Option)		

2 Installation procedure

2.1 Prepare installation tools

The following tools will be needed during inverter installation and wire connection.

Table 2-1 recommended tools for inverter installation and conductor installation

Sketch map	Name	Recommend specification	Function
	MC4 wire crimpers	M2.5~M8	Used for PV connector wire core pressure welding.
	Electric drill	Φ8	Used for inverter installation plate fixed hole drilling.
	Straight screwdriver	Φ3	Used for the AC wire installation.
	Cross screwdriver	Φ5	Used for disassembling inverter cover.
	Hammer	6 pound	Used for expansion bolt

2.2 Installation Direction and spacing dimension

The inverter shall be installed vertically or tilted backwards with a maximum angle of 10°.

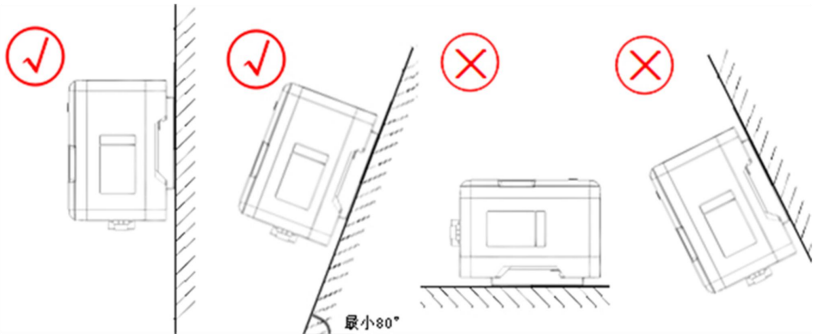

Figure 2-2 installation orientation

The minimum installation spacing dimensions are shown below:

Direction	Minimum space	Direction	Minimum space
Above	100cm	Sides	100cm
Below	100cm	Front	100cm

2.3 Installation of Inverter

Step 1:

Drill holes in the selected installation position with 1200mm for two holes of $\Phi 8$.

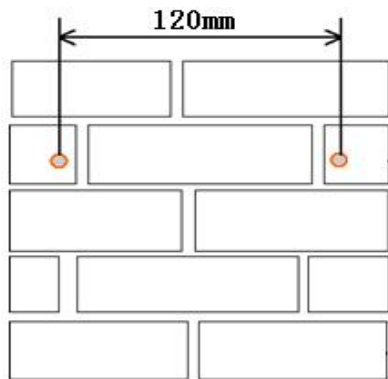

Step 2:
Use hammer to make
expansion bolt in
the holes.

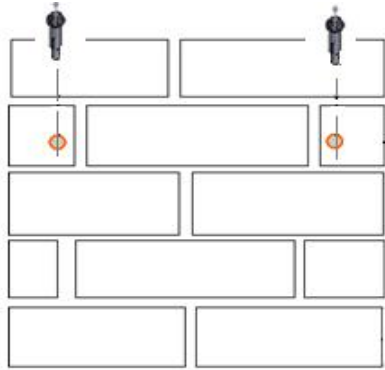

Step 3:
Align the lifting lug of
the water pump inverter
with the expansion
screw, hang it, and
finally tighten the
expansion
bolt.expansion nut.

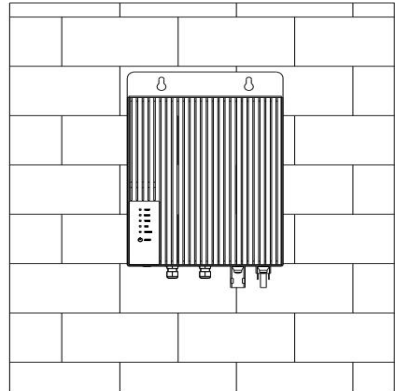

Figure 2-3 installation diagram

3 Electrical Connection

3.1 Connecting Terminals of Inverter

Input and output terminals is on the bottom of the inverter, including DC input and AC output terminal, RS 485 communication and water level sensor terminals, shown as below:

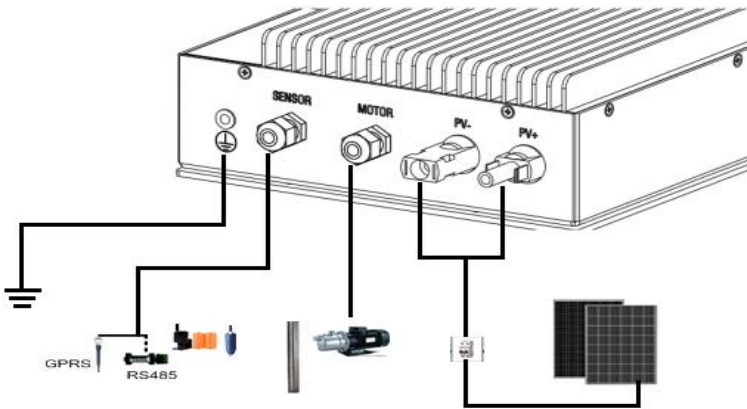

Figure 3-1 schematic diagram of external connection of inverter

Table 3-2 connection terminal marking:

Terminals	Description
PV+ / PV-	PV array DC positive/negative input terminals
MOTOR	Output terminal, connect with AC pump
SENSOR	Water level sensor signal input terminal (optional)
	Grounding terminal

Table 3-3 selection of DC circuit breaker:

Model	Recommended parameters of DC circuit breaker
JNP370L	440VDC,20A
JNP370LS	440VDC,20A
JNP550L	440VDC,20A
JNP550LS	440VDC,20A



Notice!

1. It must be DC breaker, it's prohibited to be replaced by AC breaker;
2. Shown as right side picture DC breaker should be 2 stages.

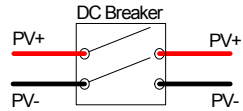

3.2 Cable Selection for Electrical Connection

Table 3-4 users can select the electrical connection cable according to the following specifications:

Model	Cable range (AWG)		
	DC side	AC side	
	PV+, PV-	U, V, W	PE
JNP370L	14-12	14-12	12
JNP370LS	14-12	14-12	12
JNP550L	14-12	14-12	12
JNP550LS	14-12	14-12	12

3.3 AC Side Electrical Connection

Step 1: AC connectors plug into Inverter bottom AC side terminal, tighten connectors. From AC connectors there are U,V,W wires to connect with AC pumps U,V,W wires .JNP370L and JNP550L drive the three-phase water pump, and JNP370LS and JNP550LS drive the single-phase water pump. Note Special precautions for driving single-phase water pump, as shown in 3.3.1.

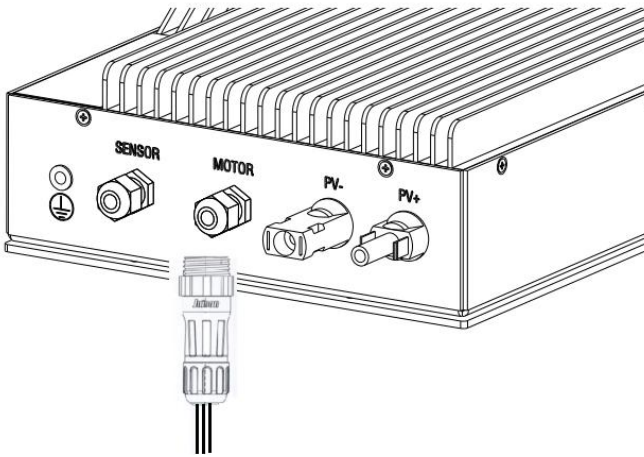

Fig. 3-5 connection diagram of inverter water pump terminal

3.3.1 Single phase pump description

Single phase pump is widely used in household and small power water delivery system with its advantages of simple

structure, low cost, low noise, easy access to power, etc. Usually, single phase pump consists of a main winding (running winding), a secondary winding (starting winding), and a starting capacitor.

Note: Some single phase pump consists of two capacitors, one starting capacitor and one running capacitor. In the connection of single phase pump, this two capacitors are always connected together, after that, the connection is same as one capacitor pump. No further description here.

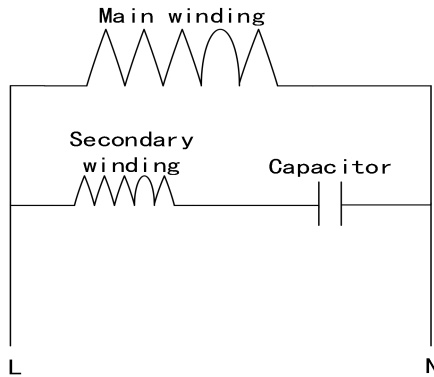

Fig. 3-6 Diagram of single phase pump inner winding

Use the company JNPXLS photovoltaic pump series inverter, driving customers themselves with the single phase of buy pumps need to affirm the startup capacitor of

single-phase water pump to remove, and then in the main winding and the auxiliary winding public side leads to a line, the main winding and the auxiliary winding each lead to a line, the other end to connect three wires and a ground to inverter standard accessories Ac connector, remove the capacitor schematic diagram as follows.

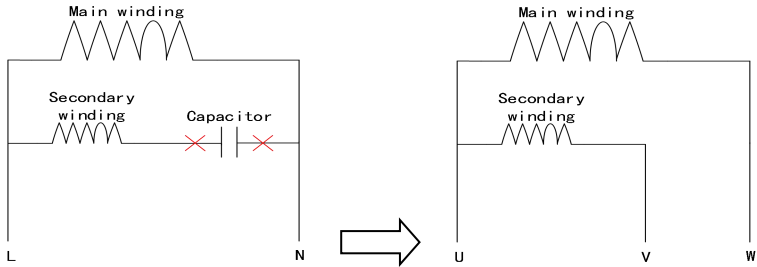
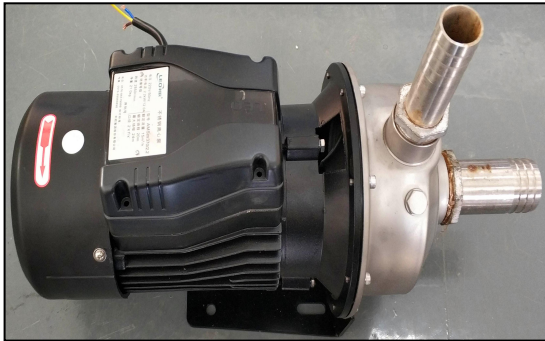

Fig. 3-7 Schematic diagram of removal for single phase pump

3.3.2 Capacitor removal example

Step 1: Put the single pump on the open and hard ground



Step 2: Remove 4 fixing screws from end cover plate with cross screwdriver and remove end cover plate.



Step 3: After remove end cover, find the terminal connected to the capacitor lead, loosen the fastening nut and remove the original wire of capacitor and motor.



Step 4: Prepare a four-core motor extension wire, fix the ground wire in the “ \perp ” position, connect the other three wires to the three terminals and fix them with nuts. Finally, cover it.



3.4 DC side connection





Danger!

When carrying the out connection between PV array and inverter, the PV array should be covered with opaque materials and the DC-side circuit-breaker should be disconnected, otherwise, the PV

array may generate dangerous voltage, cause casualty. The Non-professionals do not make the connection operation.

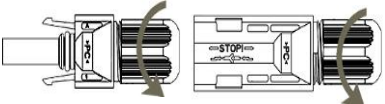
Step1: Please connect the wire of DC connector according to the following steps:

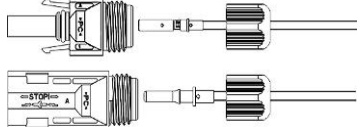
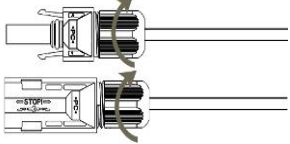
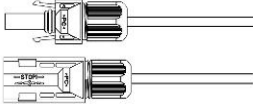
Operation instruction	Operation demonstration
1. Unscrew the fastening nuts of MC4 Connector.	
2. Strip off the DC cable insulation layer to a length of approx. 7mm. Insert the exposed end of PV Cable into the connector tube, and press tightly with wire crimpers.	
Effect figure. Remember! ! Terminals and connectors match the core, is not reversed.	
3. Pull the above finished cable with tube through the fastening nut.	
4. Plug it into the wiring slot until a sound being heard, which indicating plug into the right place. Then tighten the nut.	
Effect figure	

Step2: Plug the positive and negative connector into the corresponding terminals at the bottom of the inverter respectively.

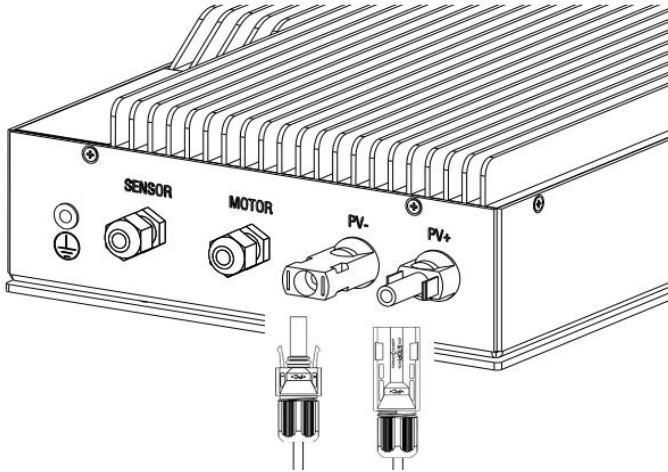

Figure 3-8 schematic diagram of inverter photovoltaic connection

3.5 Inverter grounding

Make sure Inverter grounding terminals is properly connected with grounding.

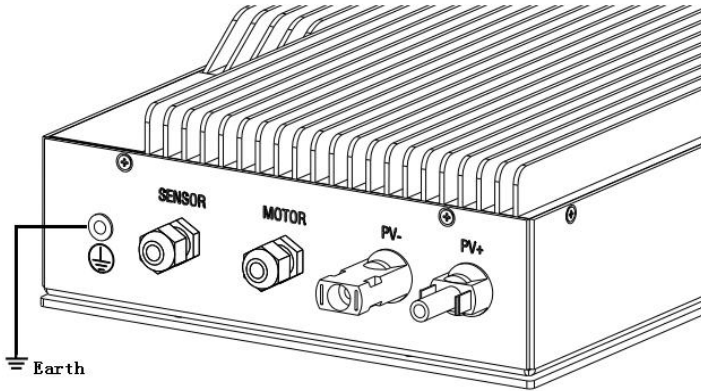
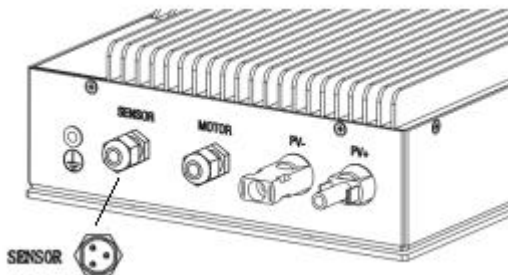

Figure 3-9 schematic diagram of inverter grounding connection

3.6 Water Level Sensor Connection

3.6.1 Water level sensor interface define

Water level sensor connector pins in inverter panel port are defined are shown below:



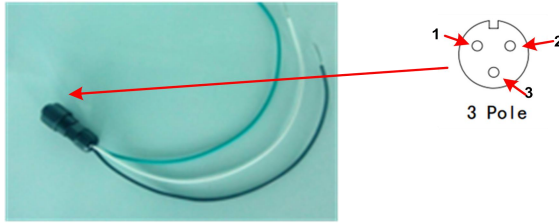

Fig. 3-10 connection diagram of inverter water level sensor

Terminal (SENSOR) connector pin	Detail
DG	Dry protection pin.
SY	Overflow protection pin.
COM	Dry protection and Overflow protection common pin.

3.6.2 Water level sensor connection

Two kinds of water level sensor you can select are shown below:



Sensor A



Sensor B

If you selected water level sensor A, then water sensor installation method is shown below:

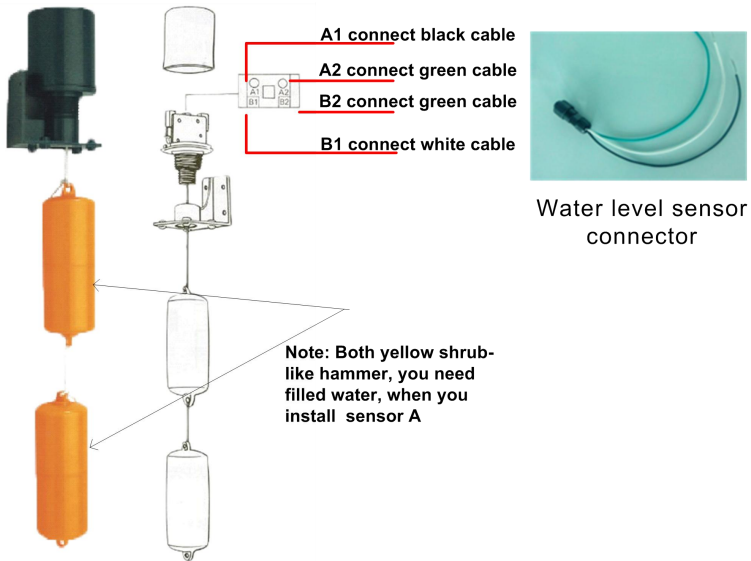

Figure 3-11 detail of water level sensor A

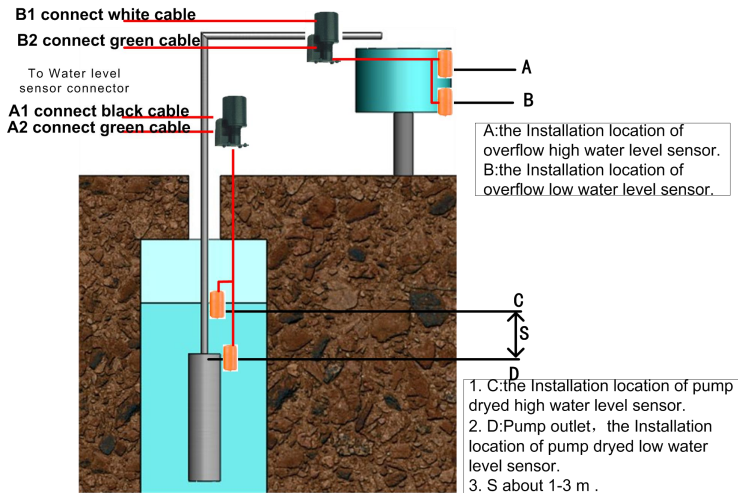

Figure 3-10 detail of water level sensor A

If you selected water level sensor B, then water sensor installation method is shown below:

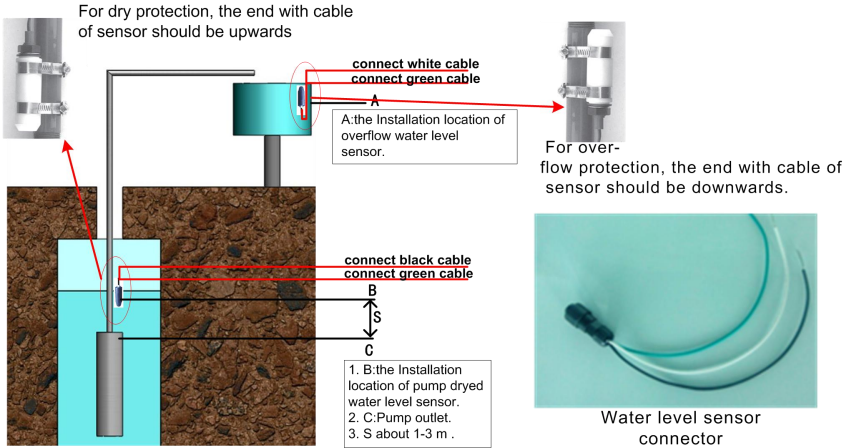



Figure 3-12 detail of water level sensor B

4 Disassembling

4.1 The Disassembling of PV Connector

Please operate according to following:

Operation instructions	Demonstration picture
DC SWITCH should be OFF before operation, and This blue ring tool shall be used to disconnect MC4	

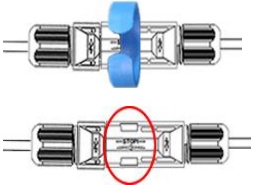
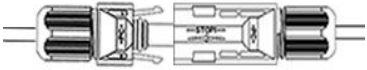
<p>Step 1: Putting blue ring tool into the hole of the MC4 totally, as shown on the picture.</p>	
<p>Step 2: it will be taken apart easily.</p>	

5 Commissioning

5.1 Verify before Commissioning

PV Arrays

The PV array should be checked before operating the inverter, and to ensure that the positive and negative mustn't be misconnect, otherwise, the damage may be caused to the inverter. Make sure that the open-circuit voltage of photovoltaic array doesn't exceed the required voltage.

DC Input

Make sure that the DC terminals of the inverter are connected correctly and maintained consistent with the PV array.

AC Output

Make sure inverter AC output terminal is properly connected and phase sequence is properly connected, and the protection ground of the system is properly connected to PE.

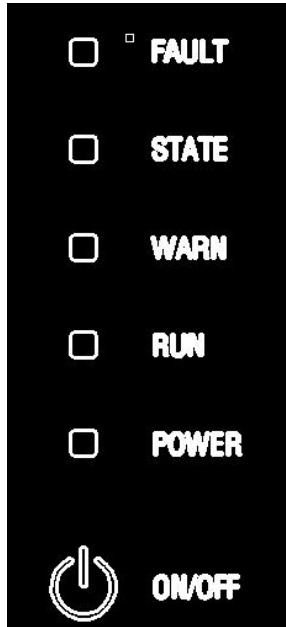

Figure5-1 LED Display

Table5-1 LED&Key Indicator Direction

LED Indicator	Name	Color	Instructions
FAULT	Faulty light	Red	Fault light, the system can not recover the fault, (when the fault occurs and the fault is not eliminated, the light is on).
STATE	STATE light	Yellow	When the system is in abnormal state, the light will be on, such as photovoltaic under voltage, system dry, overflow.
WARN	WARN light	Red	When the system is in abnormal state, the light will be on, such

			as photovoltaic under voltage, system dry, overflow system can recover fault, and the light will be on.
RUN	Running light	Green	Light on under normal operation.
POWER	Power light	Green	Light on When power on.
ON/OFF	“ON/OFF”		Press once to stop; long time press for 1s to get it started.

5.2 Inverter first commission

Choose suitable weather, with enough sunshine, and make sure the normal operation of your solar pumping system. Try to ensure that inverter work under high output power, high output frequency as much as possible. Please make sure the following condition before commissioning.

- Ensure that the inverter is connected correctly to the AC motor.
- Ensure that the polarity of PV arrays is correct.
- Ensure that ac inputs R, S and ground connections are correct.
- Check whether the system pipeline is unobstructed or not;
- Switch on the DC-side circuit breakers.

After finishing the above steps, then begin initialization.

Auto model:

- Inverter default setting is Auto model, when inverter power on, Inverter power indicator light will be on, inverter will auto operate, POWER and RUN light will be on, inverter start to work.

- After inverter operate, if RUN light turn off and other indicator light turn on, means inverter have fault,detailed troubleshooting method check out in Appendix.

Manual mode:

- Inverter default setting is Auto mode, if need to manual turn on off, need to operate through button. Press for over 3S, inverter turn on, press “ON/OFF” button together, inverter will be turn off.



Note!

1. During operation, inverter will note down operation mode of last time power off, If manual turn off, need to turn on manually next time, if last time is auto turn off, inverter will auto turn on when power on.
2. Inverter “ON/OFF” is touch botton, do not press hard!



Note!

1. AC pump motor and inverter phase sequence must be corresponding, if misconnection, will get no or less water output. When this happen, should turn off inverter, exchange U V W any two phases, then power on again.
2. First commission must check phase sequence is correct connected.
3. If choose single phase inverter, every time when inverter is power on again, inverter will be auto winding detection, after detection successfully, RUN light will turn off for 60S then turn on again.

6 Appendix: Troubleshooting

Shutdown status and troubleshooting

Condition code	Condition Name	Phenomena	Cause value	Troubleshooting
State light on	PV Array undervoltage	Inverter shutdown when the fault appeared and will automatically restart	Output energy from array changes.	Please check the input voltage from array and make sure this voltage inside inverter input voltage range. Note: In cloudy days, morning,

		after it disappear.		or down, this situation is not malfunction.
	PV array overvoltage	Inverter shutdown when the fault appeared and will automatically restart after it disappear.	Out put energy from array changes.	Please check the input voltage from array and make sure this voltage inside inverter input voltage range. Note: In cloudy days, morning, or down, this situation is not malfunction.
	Dry alarm	Inverter shut down until the water level recover or protection recover time is up, the machine will restart automatically.	Water level of source is lower than low-level water level sensor, even lower than inlet of pump.	1. Please check the water level, if the water level is ok, please check if there are air inside pump. 2. Please check the position of water level sensor.

	Weak sunshine	Inverter shutdown. When malfunction disappear, inverter can restart automatic.	Array output low.	Usually appears in early morning, dusk and cloudy days. This situation is aim to protect the motor of pump and lengthen the lifetime.
	Overflow alarm	Inverter shut down until the water level recover or protection recover time is up, the machine will restart automatically.	Water level in container higher than high-end level sensor.	If this situation appears more than once, please check onsite and set the water level sensor at a proper height.
	Output over-load	Inverter shutdown and will restart automatically after the fault disappears.	Load higher than rated output power of inverter.	Please make sure the system is proper designed. The power of pump motor should not be larger than inverter output.

	Inverter AC output over current	Inverter shutdown and will restart automatically after the fault disappears.	<ol style="list-style-type: none"> 1. Power capacity of pump motor is higher than rated output. 2. Pump motor locked-rotor, or damaged. 3. Pipe system design is not reasonable. 	<ol style="list-style-type: none"> 1. Please inspect whether pump motor is normal. 2. Please inspect whether pipeline system is in accordance with water pump or not. 3. If this happen frequently, please contact SUPPLIER.
	Output phase lose	Inverter shutdown and will restart automatically after the fault disappears.	Phase loss in inverter output.	<ol style="list-style-type: none"> 1. Please check if the output wires are proper connected and fixed. 2. If this happen frequently, please contact the supplier.
Warn light on	Busbar voltage undervoltage	Inverter shutdown and will restart automatically after the fault	PV array output changes; pump damage; inverter hardware	<ol style="list-style-type: none"> 1. Please check the input voltage from array and make sure this voltage inside inverter input voltage

		disappears.	damage.	range; 2. Check if pump motor damage; 3. Check if inverter hardware damage.
	Busbar voltage overvoltage	Inverter shutdown and will restart automatically after the fault disappears.	PV array output changes.	Please check the input voltage from array and make sure this voltage inside inverter input voltage range. Note: In cloudy days, morning, or down, this situation is not malfunction.
	Busbar overcurrent	Inverter shutdown and will restart automatically after the fault disappears.	Inverter inside storage reading fault; Inverter hardware damage.	Power on again to restart, if restart still show this fault, means inverter inside hardware damage.

	IPM FO fault	Inverter shutdown and will restart automatically after the fault disappears.	Pump damage cause output short circuit; Inverter hardware damage.	Check if pump is damaged, if pump is okay, then inverter inside hardware damage if restart failure.
	IPM over heat	Inverter shutdown and will restart automatically after the fault disappears.	Inverter radiator over heat; hardware damage.	<ol style="list-style-type: none"> 1. If external temperature is too high to cause inverter over heat, when temperature goes down, inverter will restart; 2. If cannot restart for a long time, consider inverter hardware damage. <p>Note: in Summer with high temperature, this situation is not malfunction.</p>

Malfunction and troubleshooting:

Condition code	Condition Name	Phenomena	Cause value	Troubleshooting
Fault light on	Short circuit fault (Nonrecoverable)	Inverter shutdown, non-recover malfunction. No automatic restart, only if recharged.	Output wire short circuit; inverter hardware damage	1. Please check if there is short circuit in output wires. And if pump is damaged. 2. If this happens frequently, please contact SUPPLIER.
	Motor detection fault	Inverter shutdown, non-recover malfunction. No automatic restart, only if recharged.	Inverter one phase or two phase is not properly connected with motor, or motor damage.	Please check if three phase output is properly connected, motor is damaged or not.
	Initialization fault	Inverter shutdown, non-recover malfunction. No	Inverter inside storage reading fault; Inverter	Power on again to restart, if restart still shows this fault, means

		automatic ally restart, only if recharged.	hardware damage.	inverter inside hardware damage.
--	--	--	---------------------	---